

ASL Sirène multi sons

- Sirène multi-tons carrée de 184 mm
- max. Pression sonore 120 dB (A)
- Classe de protection élevée IP66
- Type de montage optionnel avec équerre métallique
- 63 types de son au choix, 3 types de son réglables à l'extérieur
- Pression sonore avec potentiomètre réglable sans gradation
- pour applications industrielles et générales
- Combinaisons possibles de sirènes multi-tons avec des lampes

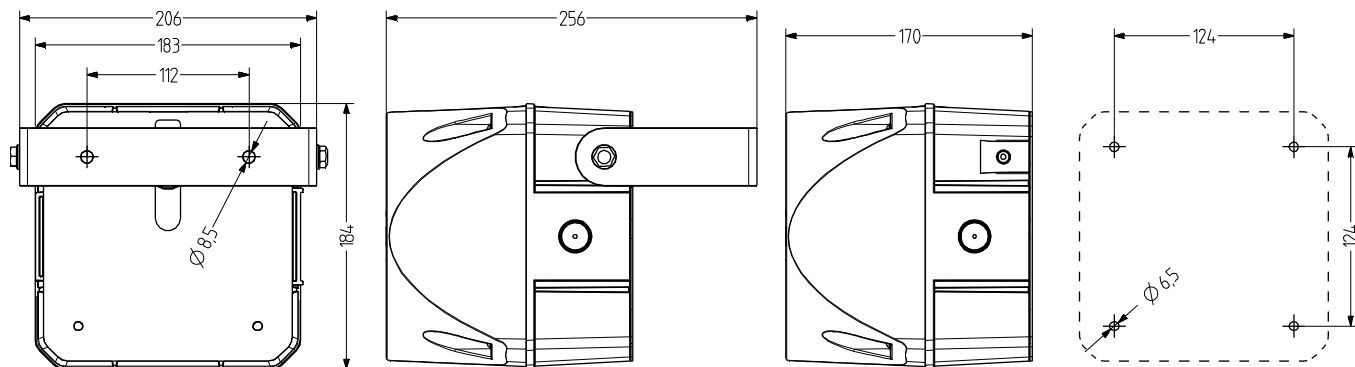

DONNÉES TECHNIQUES

Boîtier	Polycarbonate rouge (RAL 3000)
Type de montage	au choix, Ouverture pour sortie des sons, vers le bas ou horizontalement
Entrée de puissance	Face arrière : Tulle de passage 5-10 mm latéral : Vissage de câble AKV M20×1,5 7-14 mm montable
Technologie de raccordement	Borne vissée/enfichable bis 2,5 mm ²
Courant de fuite	0,003 A
Type de son	63 Sons, 3 Sons réglables de l'extérieur, voir tableau des sons

Volume sonore	120 dB (réglable avec potentiomètre)
Fréquence sonore	150-3.100 Hz
Durée de mise en marche	100 %
Température de service	-30 °C / +60 °C
Type de protection	IP66 & UL Type 4/4x/13
Grande résistance aux chocs	IK09
Poids	2,2 kg

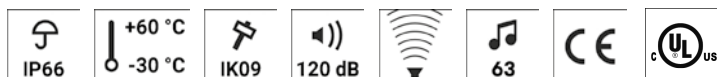

ASL

DONNÉES DE COMMANDE

Tension nominale	Plage de tension (V)	Courant nominal (A)	Fréquence du réseau	Référence
24-48 V AC/DC	21-53 V AC	1,200	50-60 Hz	874 360 408
	21-60 V DC	0,900		
110-120 V AC	+/- 10 %	0,200	50-60 Hz	874 360 310
230-240 V AC	+/- 10 %	0,100	50-60 Hz	874 360 313



AMK



AB3



AG3



AKV

























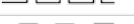







ACCESSOIRES

Type	Type d'accessoires	Poids	Référence
AMK	Set de montage aller à la combinaison de plusieurs appareils de signalisation de la même taille de construction	10 g	874 010 900
AB3	Set de montage pour coude métallique aller au montage dans n'importe quelle direction (par ex. sur les plateformes de montage)		874 033 900
AG3	Joint plat pour installation IP66 correcte sur les surfaces lisses		874 023 900
AKV	Vissage de câble M20x1,5		698 800 026



ASL

































TABLEAU DE SONS

ETAT 1 S1	Type de son	Fréquence Hz	Pictogramme	Dénomination	Application		max dB	ETAT 2 S2	ETAT 3 S3
Son 01	continu	660			Alarme Suède	—	114	Son 16	Son 12
Son 02	continu	1000			PFEER gaz toxique	—	113	Son 16	Son 25
Son 03	continu	2400				—	120	Son 21	Son 17
Son 04	discontinu	420		0,625 s allumé / 0,625 s éteint	Alarme éteinttralie AS1670	---	109	Son 21	Son 01
Son 05	discontinu	660		1,8 s allumé / 1,8 s éteint	Alarme Suède	---	114	Son 21	Son 01
Son 06	discontinu	660		0,15 s allumé / 0,15 s éteint	Alarme Suède	---	114	Son 16	Son 01
Son 07	discontinu	970		1 s allumé, 1 s éteint	Alarme PFEER, BS5839-1:2002	---	113	Son 18	Son 01
Son 08	discontinu	970 (950)		0,5 s allumé/0,5 s éteint x 3 puis 1,5 s éteint	ISO 8201 basse tonalité, US Temporal	---	113	Son 16	Son 03
Son 09	discontinu	800		0,25 s allumé / 1 s éteint		---	112	Son 27	Son 03
Son 10	discontinu	700		0,15 s allumé / 0,15 s éteint, total 1 min.	Alarme Suède SS 031711	---	112	Son 18	Son 02
Son 11	discontinu	720		0,7 s allumé / 0,3 s éteint	Alarme Industrielle Allemagne	---	111	Son 02	Son 29
Son 12	discontinu	2400		0,5 s allumé / 0,5 s éteint		---	120	Son 03	Son 01
Son 13	discontinu	2850		0,5 s allumé/0,5 s éteint x 3 puis 1,5 s éteint	ISO 8201 tonalité haute, US Temporal	---	111	Son 03	Son 17
Son 14	alterné	440 - 554		0,4 s (440Hz) / 0,1 s (554Hz)	AFNOR France, NFS 32-001	—	109	Son 16	Son 01
Son 15	alterné	554 - 440		1 Hz	Alarme Suède	—	109	Son 01	Son 16
Son 16	alterné	800 - 1000		2 Hz		—	113	Son 02	Son 09
Son 17	alterné	2400 - 2900		2 Hz		—	120	Son 03	Son 01
Son 18	alterné	1000 - 2000		1 Hz	Singapour	—	120	Son 02	Son 03
Son 19	balayé	500 - 1500		10 Hz		—	119	Son 02	Son 01
Son 20	balayé	150 - 1000		montant 10 s, 40 s allumé, descendant 10 s	Alarme Industrielle Allemagne	—	114	Son 01	Son 29
Son 21	continu	400		correspond à une trompe		—	109	Son 16	Son 02
Son 22	balayé	500 - 1200		montant en 3,75 s / 0,25 s éteint	Australie évacuation AS 2220	—	117	Son 02	Son 09
Son 23	balayé	500 - 1200		montant en 3,5 s / 0,5 s éteint	Pays-Bas NEN 2575:2000	—	117	Son 02	Son 09
Son 24	balayé	500 - 1200		0,5 s allumé/0,5 s éteint x 3 / 1,5 s éteint	Australie évacuation AS1670	—	117	Son 02	Son 09
Son 25	descendant	1200 - 500		1 Hz	Allemagne évacuation DIN 33404-3	—	117	Son 02	Son 32
Son 26	balayé	500 - 1200		0,3 Hz		—	117	Son 01	Son 32
Son 27	balayé	1400 - 1600		montant en 1 s / descendant en 0,5 s	NFC 48-265	—	119	Son 02	Son 09
Son 28	balayé	2400 - 2900		1 Hz		—	120	Son 17	Son 03
Son 29	cloche					—	120	Son 16	Son 02
Son 30	montant	500 - 2400		sirène montante en 3 s, puis cont. 2400 Hz		—	120	Son 16	Son 01
Son 31	montant	300 - 1200		sirène montante en 3 s, puis cont. 1200 Hz		—	117	Son 16	Son 01
Son 32	carillon	970 - 800		ding-dong répété, 1 Hz		—	113	Son 29	Son 01

Feu LED fixe —
Feu LED clignotant ---

ASL

TABLEAU DE SONS

ETAT 1 S1	Type de son	Fréquence Hz	Pictogramme	Dénomination	Application		max dB	ETAT 2 S2	ETAT 3 S3
Son 33	continu	340				X	109	Son 16	Son 03
Son 34	continu	500				X	109	Son 16	Son 03
Son 35	continu	825				X	113	Son 16	Son 03
Son 36	continu	1500				X	118	Son 18	Son 02
Son 37	continu	2850				X	111	Son 21	Son 01
Son 38	discontinu	660		0,5 s allumé / 0,5 s éteint	Alarme Suède	X	114	Son 02	Son 32
Son 39	discontinu	680		0,875 s allumé / 0,675 s éteint		X	114	Son 03	Son 32
Son 40	discontinu	950		1 s allumé / 1 s éteint		X	114	Son 02	Son 32
Son 41	discontinu	1000		1 s allumé / 1 s éteint	PFEER Alarme générale	X	113	Son 16	Son 03
Son 42	discontinu	800		4 ms allumé / 4 ms éteint		X	112	Son 58	Son 03
Son 43	discontinu	825		0,5 s allumé / 0,5 s éteint		X	113	Son 16	Son 03
Son 44	discontinu	825		2,5 s allumé, 2,5 s éteint x 7, puis 7 s pulsé	IMO SOLAS III/50+SOLAS III/6,4	X	113	Son 17	Son 02
Son 45	alterné	440 - 554		1 Hz		X	109	Son 16	Son 01
Son 46	alterné	825 - 1075		1 Hz		X	114	Son 48	Son 02
Son 47	alterné	825 - 1025		2 Hz		X	114	Son 48	Son 03
Son 48	alterné	2500 - 3100		0,5 Hz		X	117	Son 60	Son 03
Son 49	alterné	2400 - 2850		2 Hz		X	120	Son 12	Son 03
Son 50	alterné	500 - 900		2 Hz		X	114	Son 41	Son 02
Son 51	alterné	1200 - 1400		25 Hz		X	119	Son 41	Son 02
Son 52	balayé	300 - 1200		1 Hz		X	117	Son 03	Son 32
Son 53	balayé	500 - 1000		0,15 Hz		X	114	Son 41	Son 02
Son 54	balayé	500 - 1200		3 Hz		X	117	Son 41	Son 02
Son 55	balayé	700 - 1500		0,3 Hz		X	119	Son 16	Son 02
Son 56	balayé	800 - 1000		7 Hz		X	114	Son 16	Son 02
Son 57	balayé	800 - 1000		50 Hz		X	114	Son 16	Son 02
Son 58	balayé	2400 - 2900		7 Hz		X	120	Son 17	Son 03
Son 59	balayé	2400 - 2900		50 Hz		X	120	Son 17	Son 03
Son 60	balayé	2400 - 2900		3 Hz		X	120	Son 17	Son 03
Son 61	montant	0 - 800		sirène montante en 3 s, puis cont. 800 Hz		X	114	Son 16	Son 01
Son 62	carillon	554 - 440		ding-dong répété, 1 Hz		X	109	Son 29	Son 01
Son 63	carillon	554 - 440		ding-dong simple		X	109	Son 29	Son 01

