

## ADL Mehrtonsirene mit LED Licht-Indikator

- 184 mm große quadratische Mehrtonsirene mit eingebautem LED Dauer-/Blinklicht-Indikator
- Lichtarten extern ansteuerbar
- für industrielle und allgemeine Anwendungen
- UV-stabilisiertes Material
- 63 Tonarten auswählbar, 3 Tonarten extern ansteuerbar
- max. 120 dB (A) Schalldruck, stufenlos regelbar
- optionale Montageart mit Metallwinkel

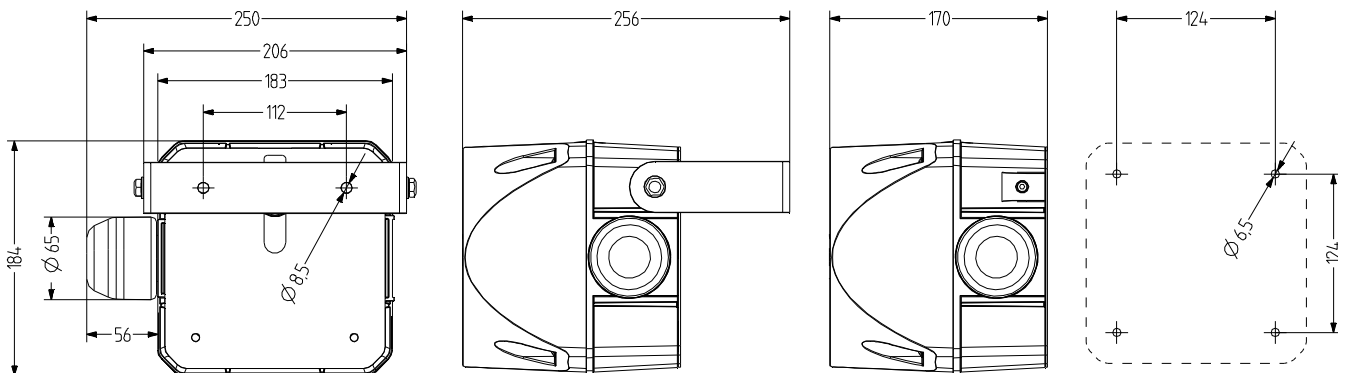

### TECHNISCHE DATEN

Gehäuse	184 mm (quadratisch), Polycarbonat rot
Kalotte	Polycarbonat, innen gerippt orange, rot, klar, blau, grün oder gelb
Montageart	beliebig, Schallaustrittsöffnung nach unten oder waagrecht
Anschlusstechnik	Schraub-Steck-Klemme bis 2,5 mm <sup>2</sup>
Tonart	63 Töne, 3 Töne extern ansteuerbar, diverse (siehe Tontabelle)
Lichtart	Dauerlicht oder Blinklicht
Lautstärke	120 dB (einstellbar durch Potentiometer)

Lichtstärke	3 Cd
Blitz-/Blinkfrequenz	1 Hz
Tonfrequenz	150-3.100 Hz
Einschaltdauer	100 %
Lebensdauer	Leuchtmittel: 100.000 h
Betriebstemperatur	-30 °C / +60 °C
Schutzart	IP65
Schlagfestigkeit	IK07
Gewicht	2,28 kg

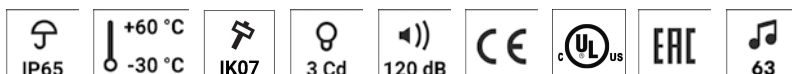

## ADL

## BESTELLDATEN

Kalottenfarbe	Nennspannung	Spannungsbereich (V)	Nennstrom (A)	Artikel-Nr.
orange	24 V AC/DC	+/- 10 %	1,260	875361405
	110-120 V AC	+/- 10 %	0,230	875361310
	230-240 V AC	+/- 10 %	0,130	875361313
rot	24 V AC/DC	+/- 10 %	1,260	875362405
	110-120 V AC	+/- 10 %	0,230	875362310
	230-240 V AC	+/- 10 %	0,130	875362313
klar	24 V AC/DC	+/- 10 %	1,260	875364405
	110-120 V AC	+/- 10 %	0,230	875364310
	230-240 V AC	+/- 10 %	0,130	875364313
blau	24 V AC/DC	+/- 10 %	1,260	875365405
	110-120 V AC	+/- 10 %	0,230	875365310
	230-240 V AC	+/- 10 %	0,130	875365313
grün	24 V AC/DC	+/- 10 %	1,260	875366405
	110-120 V AC	+/- 10 %	0,230	875366310
	230-240 V AC	+/- 10 %	0,130	875366313
gelb	24 V AC/DC	+/- 10 %	1,260	875367405
	110-120 V AC	+/- 10 %	0,230	875367310
	230-240 V AC	+/- 10 %	0,130	875367313



AMK



AB3



AG3



AKV































## ZUBEHÖR

Type	Art des Zubehörs	Gewicht	Artikel-Nr.
AMK	Montagesatz zur Kombination von mehreren Signalgeräten der selben Baugröße	10 g	874010900
AB3	Anbausatz für Metallwinkel zur Montage in beliebiger Richtung (z.B. auf Montageplattformen)		874033900
AG3	Flachdichtung für Installation auf glatten Oberflächen		874023900
AKV	Kabelverschraubung M20x1,5		698800026



## ADL

## TONARTEN

STUFE 1 S1	Tonart	Frequenz Hz	Piktogramm	Wiederholgeschwindigkeit	spezielle Anwendung	max dB	STUFE 2 S2	STUFE 3 S3
Ton 01	Dauerton	660			Alarm Schweden	114	Ton 16	Ton 12
Ton 02	Dauerton	1000			PFEER Gasalarm	113	Ton 16	Ton 25
Ton 03	Dauerton	2400				120	Ton 21	Ton 17
Ton 04	pulsierend	420		0,625 s an / 0,625 s aus	Alarm Australien AS1670	109	Ton 21	Ton 01
Ton 05	pulsierend	660		1,8 s an / 1,8 s aus	Alarm Schweden	114	Ton 21	Ton 01
Ton 06	pulsierend	660		0,15 s an / 0,15 s aus	Alarm Schweden	114	Ton 16	Ton 01
Ton 07	pulsierend	970		1 s an, 1 s aus	PFEER Alarm, BS5839-1:2002	113	Ton 18	Ton 01
Ton 08	pulsierend	970 (950)		0,5 s an/0,5 s aus x 3 dann 1,5 s aus	ISO 8201 niedriger Ton, US Temporal	113	Ton 16	Ton 03
Ton 09	pulsierend	800		0,25 s an / 1 s aus	Alarm Schweden SS 031711	112	Ton 27	Ton 03
Ton 10	pulsierend	700		0,15 s an / 0,15 s aus, total 1 min.	Industrie-Alarm Deutschland	112	Ton 18	Ton 02
Ton 11	pulsierend	720		0,7 s an / 0,3 s aus		111	Ton 02	Ton 29
Ton 12	pulsierend	2400		0,5 s an / 0,5 s aus	ISO 8201 hoher Ton, US Temporal	120	Ton 03	Ton 01
Ton 13	pulsierend	2850		0,5 s an/0,5 s aus x 3 dann 1,5 s aus	AFNOR Frankreich, NFS 32-001	111	Ton 03	Ton 17
Ton 14	alternierend	440 - 554		0,4 s (440Hz) / 0,1 s (554Hz)	Alarm Schweden	109	Ton 16	Ton 01
Ton 15	alternierend	554 - 440		1 Hz		109	Ton 01	Ton 16
Ton 16	alternierend	800 - 1000		2 Hz		113	Ton 02	Ton 09
Ton 17	alternierend	2400 - 2900		2 Hz		120	Ton 03	Ton 01
Ton 18	alternierend	1000 - 2000		1 Hz	Singapur	120	Ton 02	Ton 03
Ton 19	ansteigend	500 - 1500		10 Hz		119	Ton 02	Ton 01
Ton 20	ansteigend	150 - 1000		ansteigend 10 s, 40 s an, abfallend 10 s	Industrie-Alarm Deutschland	114	Ton 01	Ton 29
Ton 21	Dauerton	400		simulierte Hupe		109	Ton 16	Ton 02
Ton 22	ansteigend	500 - 1200		ansteigend in 3,75 s / 0,25 s aus	Evakuierung Australien AS 2220	117	Ton 02	Ton 09
Ton 23	ansteigend	500 - 1200		ansteigend in 3,5 s / 0,5 s aus	Niederlande NEN 2575:2000	117	Ton 02	Ton 09
Ton 24	ansteigend	500 - 1200		0,5 s an/0,5 s aus x 3 / 1,5 s aus	Evakuierung Australien AS1670	117	Ton 02	Ton 09
Ton 25	abfallend	1200 - 500		1 Hz	Evakuierung Deutschland DIN 33404-3	117	Ton 02	Ton 32
Ton 26	ansteigend	500 - 1200		0,3 Hz		117	Ton 01	Ton 32
Ton 27	ansteigend	1400 - 1600		ansteigend in 1 s/abfallend in 0,5 s	NFC 48-265	119	Ton 02	Ton 09
Ton 28	ansteigend	2400 - 2900		1 Hz		120	Ton 17	Ton 03
Ton 29	Wecker					120	Ton 16	Ton 02
Ton 30	langsam ansteigend	500 - 2400		ansteigend in 3 s, dann konstant 2400 Hz		120	Ton 16	Ton 01
Ton 31	langsam ansteigend	300 - 1200		ansteigend in 3 s, dann konstant 1200 Hz		117	Ton 16	Ton 01
Ton 32	Gong	970 - 800		wiederholender Gong, 1 Hz		113	Ton 29	Ton 01

## ADL

## TONARTEN

STUFE 1 S1	Tonart	Frequenz Hz	Piktogramm	Wiederholgeschwindigkeit	spezielle Anwendung	max dB	STUFE 2 S2	STUFE 3 S3
Ton 33	Dauerton	340				109	Ton 16	Ton 03
Ton 34	Dauerton	500				109	Ton 16	Ton 03
Ton 35	Dauerton	825				113	Ton 16	Ton 03
Ton 36	Dauerton	1500				118	Ton 18	Ton 02
Ton 37	Dauerton	2850				111	Ton 21	Ton 01
Ton 38	pulsierend	660		0,5 s an / 0,5 s aus	Alarm Schweden	114	Ton 02	Ton 32
Ton 39	pulsierend	680		0,875 s an / 0,675 s aus		114	Ton 03	Ton 32
Ton 40	pulsierend	950		1 s an / 1 s aus		114	Ton 02	Ton 32
Ton 41	pulsierend	1000		1 s an / 1 s aus	PFEER Allgemeiner Alarm	113	Ton 16	Ton 03
Ton 42	pulsierend	800		4 ms an / 4 ms aus		112	Ton 58	Ton 03
Ton 43	pulsierend	825		0,5 s an / 0,5 s aus		113	Ton 16	Ton 03
Ton 44	pulsierend	825		2,5 s an, 2,5 s aus x 7, dann 7 s Takt	IMO SOLAS III/50+SOLAS III/6,4	113	Ton 17	Ton 02
Ton 45	alternierend	440 - 554		1 Hz		109	Ton 16	Ton 01
Ton 46	alternierend	825 - 1075		1 Hz		114	Ton 48	Ton 02
Ton 47	alternierend	825 - 1025		2 Hz		114	Ton 48	Ton 03
Ton 48	alternierend	2500 - 3100		0,5 Hz		117	Ton 60	Ton 03
Ton 49	alternierend	2400 - 2850		2 Hz		120	Ton 12	Ton 03
Ton 50	alternierend	500 - 900		2 Hz		114	Ton 41	Ton 02
Ton 51	alternierend	1200 - 1400		25 Hz		119	Ton 41	Ton 02
Ton 52	ansteigend	300 - 1200		1 Hz		117	Ton 03	Ton 32
Ton 53	ansteigend	500 - 1000		0,15 Hz		114	Ton 41	Ton 02
Ton 54	ansteigend	500 - 1200		3 Hz		117	Ton 41	Ton 02
Ton 55	ansteigend	700 - 1500		0,3 Hz		119	Ton 16	Ton 02
Ton 56	ansteigend	800 - 1000		7 Hz		114	Ton 16	Ton 02
Ton 57	ansteigend	800 - 1000		50 Hz		114	Ton 16	Ton 02
Ton 58	ansteigend	2400 - 2900		7 Hz		120	Ton 17	Ton 03
Ton 59	ansteigend	2400 - 2900		50 Hz		120	Ton 17	Ton 03
Ton 60	ansteigend	2400 - 2900		3 Hz		120	Ton 17	Ton 03
Ton 61	langsam ansteigend	0 - 800		ansteigend in 3 s, dann konstant 800 Hz		114	Ton 16	Ton 01
Ton 62	Gong	554 - 440		wiederholender Gong, 1 Hz		109	Ton 29	Ton 01
Ton 63	Gong	554 - 440		einfacher Gong		109	Ton 29	Ton 01

