

ADM Sirène multi sons avec indicateur LED lumineux

- Sirène multi-ton carrée 132 mm GM avec indicateur de LED à éclairage permanent / clignotant intégré
- Types de lumière réglable de l'extérieur
- pour applications industrielles et générales
- Matériau résistant aux UV
- 32 types de son au choix, 3 types de son réglables à l'extérieur
- max. Pression sonore 113 dB (A), réglable sans gradations
- Type de montage optionnel avec équerre métallique

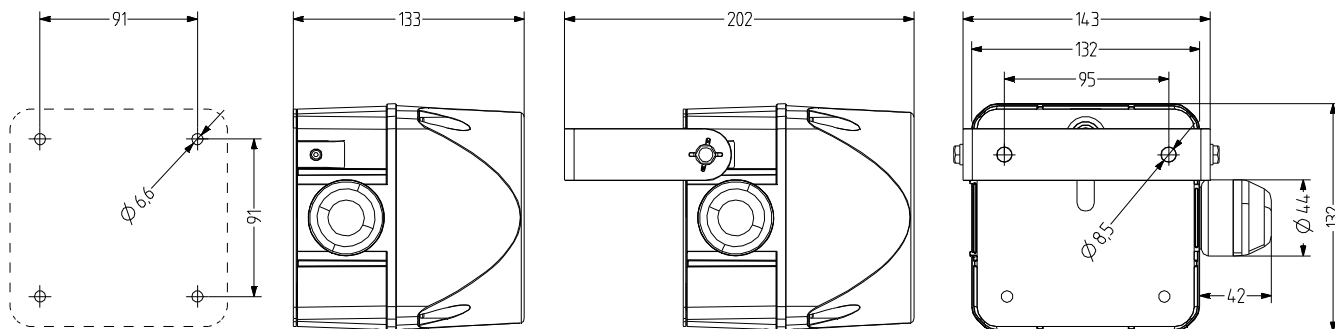

DONNÉES TECHNIQUES

Boîtier	132 mm (carré), Polycarbonate rouge
Calotte	Polycarbonate, intérieur rainuré orange, rouge, clair, bleu, vert ou jaune
Type de montage	au choix, Ouverture pour sortie des sons, vers le bas ou horizontalement
Technologie de raccordement	Borne vis-fiche bis 2,5 mm ²
Type d'éclairage	Feu fixe ou Feu clignotant
Luminosité	2 Cd
Fréquence du flash/de clignotement	1 Hz

Type de son	32 Sons, 3 Sons réglables de l'extérieur, divers (voir tableau des sons)
Volume sonore	113 dB (réglable avec potentiomètre)
Fréquence sonore	150-2.900 Hz
Durée de mise en marche	100 %
Durée de vie	Lampes : 100.000 h
Température de service	-30 °C / +60 °C
Type de protection	IP65
Grande résistance aux chocs	IK07
Poids	660 g

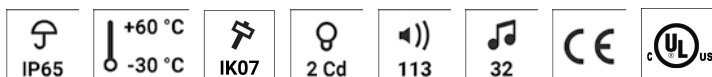

ADM

DONNÉES DE COMMANDE

Couleur de calotte	Tension nominale	Plage de tension (V)	Courant nominal (A)	Référence
orange	24 V AC/DC	+/- 10 %	0,267	875 271 405
	110-120 V AC	+/- 10 %	0,100	875 271 310
	230-240 V AC	+/- 10 %	0,100	875 271 313
rouge	24 V AC/DC	+/- 10 %	0,267	875 272 405
	110-120 V AC	+/- 10 %	0,100	875 272 310
	230-240 V AC	+/- 10 %	0,100	875 272 313
jaune	24 V AC/DC	+/- 10 %	0,267	875 277 405
	110-120 V AC	+/- 10 %	0,100	875 277 310
	230-240 V AC	+/- 10 %	0,100	875 277 313



AMK



AB2



AG2



AKV













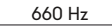

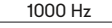

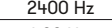

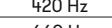

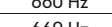

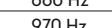

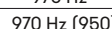



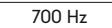

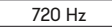

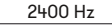

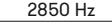

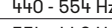

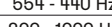

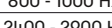

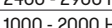

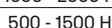

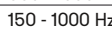

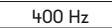

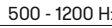

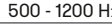

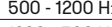

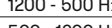

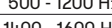

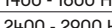

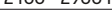

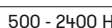

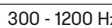
ACCESSOIRES

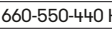
Type	Type d'accessoires	Poids	Référence
AMK	Set de montage aller à la combinaison de plusieurs appareils de signalisation de la même taille de construction	10 g	874 010 900
AB2	Set de montage pour coude métallique aller au montage dans n'importe quelle direction (par ex. sur les plateformes de montage)		874 032 900
AG2	Joint plat pour installation sur les surfaces lisses		874 022 900
AKV	Vissage de câble M20×1,5		698 800 026

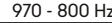

ADM

TABLEAU DE SONS

STAGE 1 S1	Tone type	Frequency Hz	Pictogram	Repeat rate	Specific application	ASS-T/ADS-T	ASM	ASL	ASX	STAGE 2 S2	STAGE 3 S3	
						max dB	 max dB	max dB	max dB			
	Tone 01	continuous	660 Hz		Swedish alarm	103	107	114	116	tone 16	tone 12	
	Tone 02	continuous	1000 Hz		PFEER toxic gas	97	110	113	121	tone 16	tone 25	
	Tone 03	continuous	2400 Hz			106	111	120	125	tone 21	tone 17	
	Tone 04	intermittent	420 Hz		0,625 s on / 0,625 s off	Australian alert AS1670	98	106	109	117	tone 21	tone 01
	Tone 05	intermittent	660 Hz		1,8 s on - 1,8 s off	Swedish alarm	103	107	114	117	tone 21	tone 01
	Tone 06	intermittent	660 Hz		0,15 s on / 0,15 s off	Swedish alarm	103	107	114	117	tone 16	tone 01
	Tone 07	intermittent	970 Hz		1 s on, 1 sec off	PFEER Alarm, BS5839-1:2002	99	111	113	122	tone 18	tone 01
	Tone 08	intermittent	970 Hz (950)		0,5 s on/0,5 s off x 3 then 1 s off	ISO 8201 low tone, US Temporal	101	111	113	122	tone 16	tone 03
	Tone 09	intermittent	800 Hz		0,25 s on / 1 s off		108	112	112	124	tone 27	tone 03
	Tone 10	intermittent	700 Hz		0,15 s on / 0,15 s off, total 1 min.	Swedish alarm SS 031711	102	107	112	119	tone 18	tone 02
	Tone 11	intermittent	720 Hz		0,7 s on / 0,3 s off	Industrial Alarm Germany	102	110	111	123	tone 02	tone 29
	Tone 12	intermittent	2400 Hz		0,5 s on / 0,5 s off		106	111	120	126	tone 03	tone 01
	Tone 13	intermittent	2850 Hz		0,5 s on/0,5 s off x 3 then 1 s off	ISO 8201 high tone, US Temporal	97	108	111	120	tone 03	tone 17
	Tone 14	alternating	440 - 554 Hz		0,4 s (440Hz) / 0,1 s (554Hz)	AFNOR France, NFS 32-001	103	109	109	118	tone 16	tone 01
	Tone 15	alternating	554 - 440 Hz		1 Hz	Swedish alarm	103	109	109	118	tone 01	tone 16
	Tone 16	alternating	800 - 1000 Hz		2 Hz		108	113	113	121	tone 02	tone 09
	Tone 17	alternating	2400 - 2900 Hz		2 Hz		106	111	120	126	tone 03	tone 01
	Tone 18	alternating	1000 - 2000 Hz		1 Hz	Singapore	107	110	120	127	tone 02	tone 03
	Tone 19	sweeping	500 - 1500 Hz		10 Hz		108	113	119	124	tone 02	tone 01
	Tone 20	sweeping	150 - 1000 Hz		rising 10 s, 40 s on, falling 10 s	Industrial Alarm Germany	108	113	114	123	tone 25	tone 29
	Tone 21	continuous	400 Hz		simulated horn		101	106	109	115	tone 16	tone 02
	Tone 22	sweeping	500 - 1200 Hz		rising in 3,75 s / 0,25 s off	Australian evacuation AS 2220	108	113	117	124	tone 02	tone 09
	Tone 23	sweeping	500 - 1200 Hz		rising in 3,5 s / 0,5 s off	Netherlands NEN 2575:2000	108	113	117	124	tone 02	tone 09
	Tone 24	sweeping	500 - 1200 Hz		0,5 s on/0,5 s off x 3 / 1,5 s off	Australia AS1670 evacuation	108	113	117	124	tone 02	tone 09
	Tone 25	sweeping	1200 - 500 Hz		1 Hz	evacuation Germany, DIN 33404-3	108	113	117	124	tone 02	tone 32
	Tone 26	sweeping	500 - 1200 Hz		0,3 Hz		108	113	117	124	tone 01	tone 32
	Tone 27	sweeping	1400 - 1600 Hz		rising in 1 s/falling in 0,5 s	NFC 48-265	102	110	119	124	tone 02	tone 09
	Tone 28	sweeping	2400 - 2900 Hz		1 Hz		106	111	120	126	tone 17	tone 03
	Tone 29	bell					102	108	120	122	tone 16	tone 02
	Tone 30	slow rise	500 - 2400 Hz		siren rising in 3 s, then cont. 2400 Hz		108	113	120	127	tone 16	tone 01
	Tone 31	slow rise	300 - 1200 Hz		siren rising in 3 s, then cont. 1200 Hz		108	113	117	124	tone 16	tone 01
	Tone 32	3-tone gong	660-550-440 Hz		repeating 3-tone gong, 7s		90	93	X	X	tone 29	tone 01
		chime	970 - 800 Hz		repeating ding-dong, 1 Hz		X	X	113	123	tone 29	tone 01