

EHL Multi-tone alarm sounder

- Ø 125 mm electronic multi-tone alarm sounder
- Short, fixed loudspeaker
- Max. 110 dB (A) sound pressure
- High degree of protection IP 66

- Type D: 1 of 15 tones can be selected via DIP switch
- Type K: all 15 tones can be switched externally
- Tone and timing frequencies can be adjusted by potentiometer
- Robust die-cast aluminium housing, epoxy powder-coated

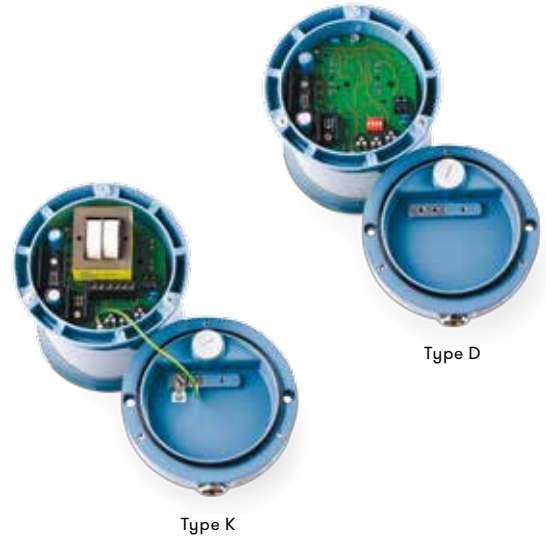

TECHNICAL DATA

Housing	Die-cast aluminium, epoxy powder-coated grey (RAL 7000)
Type of mounting	any, Sound outlet opening at bottom or horizontal side: Cable gland 5–12 mm or from bottom
Cable entry	side: Cable gland 5–12 mm or from bottom
Connection technology	Terminal up to 2.5 mm ² single wire
Tone	Type D: 15 tones can be selected with DIP switch, type K: 15 tones can be switched with terminal, see tone table
Volume	110 dB
Tone frequency	0-1.500 Hz (can be adjusted with Potentiometer)
Duty cycle	100 %
Operating temperature	-30 °C / +60 °C
Degree of protection	IP66
Weight	1,5 kg

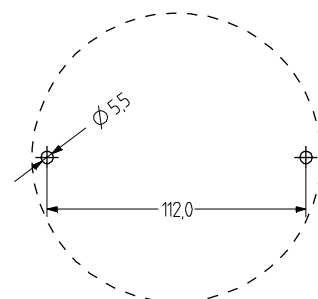
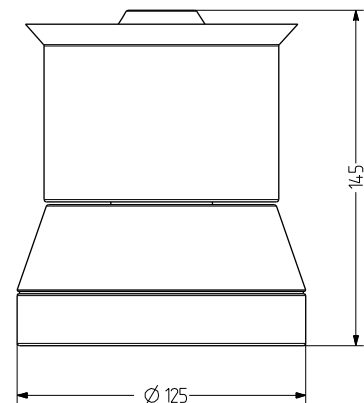





























EHL

ORDER DATA

Tone selection type	Nominal voltage	Voltage range (V)	Nominal current (A)	Mains frequency	Order number
Type D	12-24 V AC/DC	+/- 10 %	1,000		730 010 405
	110-120 V AC	+/- 10 %	0,120	40-60 Hz	730 010 310
	230-240 V AC	+/- 10 %	0,060	40-60 Hz	730 010 313
Type K	12-24 V AC/DC	+/- 10 %	1,000		730 020 405
	110-120 V AC	+/- 10 %	0,120	40-60 Hz	730 020 310
	230-240 V AC	+/- 10 %	0,060	40-60 Hz	730 020 313

TONE TABLE

DIP Switch	Terminal	Tone Type	Frequency (Hz)		Speed Hz	Volume (dB) [depends on frequency] dB		
			upper	lower				
1	 open	triangle tone		1.500	500	7-22	105	
2	 3-4	continuous tone		500-1.500			110	
3	 3-5	continuous tone			500-1.500		110	
4	 3-5 & 3-4	interrupted tone		500-1.500		0,5-1,5	110	
5	 3-6	interrupted tone			500-1.500		0,5-1,5	110
6	 3-6 & 3-4	alternating tone		500-1.500	500-1.500		0,5-1,5	110
7	 3-6 & 3-5	saw tooth tone ascending		500-1.500	500-1.500		0,5-1,5	110
8	 3-6 & 3-5 & 3-4	saw tooth tone descending		500-1.500	500-1.500		0,5-1,5	110
9	 3-7	sinus tone		500-1.500	500-1.500		0,5-1,5	105
10	 3-7 & 3-4	DIN emergency		1.200	500	1	105	
11	 3-7 & 3-5	siren tone		500-1.500	500-1.500		2-4 s	110
12	 3-7 & 3-5 & 3-4	Horn (continuous)			100-350		100	
13	 3-7 & 3-6	three tone gong				2-4 s	92	
14	 3-7 & 3-6 & 3-4	two tone gong		660-550-440		2-3 s	90	
15	 3-7 & 3-6 & 3-5	Gong		550-440	500-1.500		1-3 s	104

Customer specific sound types available in request and surcharge.



Electronic