

# ACL Multi-tone alarm sounder with LED light indicator

- 184 mm cubic-design multi-tone alarm sounder with built-in LED strobe light indicator
- 2 different strobe patterns, can be switched externally
- For industrial and general applications
- UV-stabilised material
- 63 tones can be selected, 3 tones can be switched externally
- Max. 120 dB (A) sound pressure, infinitely adjustable
- Optional mounting type using metal bracket

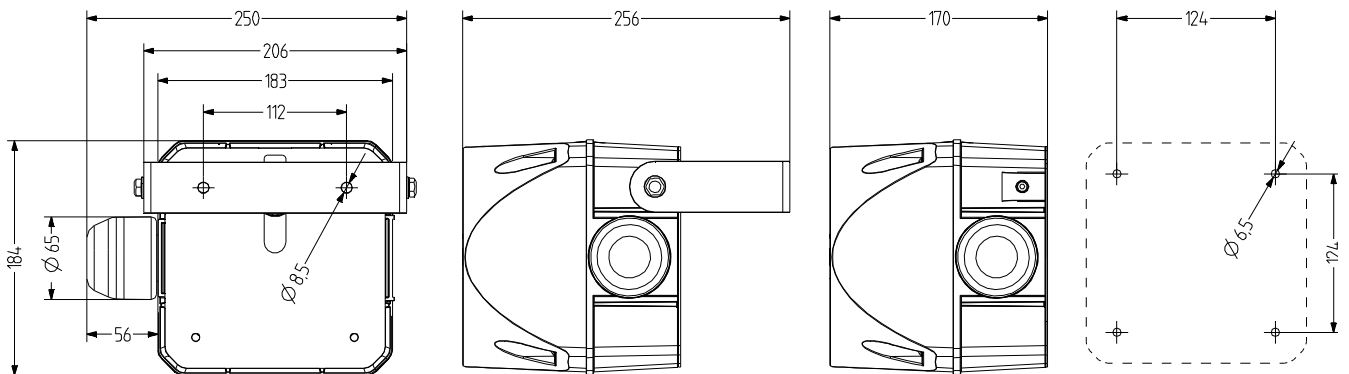

## TECHNICAL DATA

Housing	184 mm (square), Polycarbonate red
Lens	Polycarbonate, ribbed inside orange, red, clear, blue, green or yellow
Type of mounting	any, Sound outlet opening at bottom or horizontal
Connection technology	Screw/plug-in terminal up to 2,5 mm <sup>2</sup>
Beacon type	LED strobe beacon
Luminous intensity	6 Cd
Strobe/flash frequency	1 Hz and 1,4 Hz
Tone	63 Tones, 3 Tones can be switched externally, various (see tone table)

Volume	120 dB (can be adjusted with potentiometer)
Tone frequency	150-3.100 Hz
Duty cycle	100 %
Service life	Light source: 100.000 h
Operating temperature	-30 °C / +60 °C
Degree of protection	IP65
Impact resistance	IK07
Weight	2,28 kg

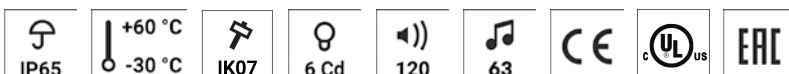

# ACL

## ORDER DATA

Lens colour	Nominal voltage	Voltage range (V)	Nominal current (A)	Order number
orange	24 V AC/DC	+/- 10 %	1,205	875 761 405
	110-120 V AC	+/- 10 %	0,215	875 761 310
	230-240 V AC	+/- 10 %	0,130	875 761 313
red	24 V AC/DC	+/- 10 %	1,205	875 762 405
	110-120 V AC	+/- 10 %	0,215	875 762 310
	230-240 V AC	+/- 10 %	0,130	875 762 313
clear	24 V AC/DC	+/- 10 %	1,205	875 764 405
	110-120 V AC	+/- 10 %	0,215	875 764 310
	230-240 V AC	+/- 10 %	0,130	875 764 313
blue	24 V AC/DC	+/- 10 %	1,205	875 765 405
	110-120 V AC	+/- 10 %	0,215	875 765 310
	230-240 V AC	+/- 10 %	0,130	875 765 313
green	24 V AC/DC	+/- 10 %	1,205	875 766 405
	110-120 V AC	+/- 10 %	0,215	875 766 310
	230-240 V AC	+/- 10 %	0,130	875 766 313
yellow	24 V AC/DC	+/- 10 %	1,205	875 767 405
	110-120 V AC	+/- 10 %	0,215	875 767 310
	230-240 V AC	+/- 10 %	0,130	875 767 313



AMK



AB3



AG3



AKV

## ACCESSORIES

Type	Type of accessory	Weight	Order number
AMK	Mounting set for combining several pieces of signalling equipment of the same size	10 g	874 010 900
AB3	Mounting set for metal bracket for mounting in any direction (e.g. on mounting platforms)		874 033 900
AG3	Flat seal for installation on smooth surfaces		874 023 900
AKV	Cable gland M20x1,5		698 800 026

























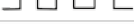





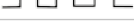

# ACL

## STONE TABLE

STAGE 1	Tone type	Frequency Hz	Pictogram	Repeat rate	Specific application	max dB	STAGE 2 S2	STAGE 3 S3
S1								
Tone 01	continuous	660			Swedish Alarm	116	Tone 16	Tone 12
Tone 02	continuous	1000			PFEER toxic gas	117	Tone 16	Tone 25
Tone 03	continuous	2400				124	Tone 21	Tone 17
Tone 04	intermittent	420		0,625 s on / 0,625 s off	Australian alert AS1670	114	Tone 21	Tone 01
Tone 05	intermittent	660		1,8 s on / 1,8 s off	Swedish Alarm	120	Tone 21	Tone 01
Tone 06	intermittent	660		0,15 s on / 0,15 s off	Swedish Alarm	116	Tone 16	Tone 01
Tone 07	intermittent	970		1 s on, 1 s off	PFEER Alarm, BS5839-1:2002	118	Tone 18	Tone 01
Tone 08	intermittent	970 (950)		0,5 s on/0,5 s off x 3 dann 1,5 s off	ISO 8201 low tone, US Temporal	120	Tone 16	Tone 03
Tone 09	intermittent	800		0,25 s on / 1 s off		120	Tone 27	Tone 03
Tone 10	intermittent	700		0,15 s on / 0,15 s off, total 1 min.	Swedish Alarm SS 031711	118	Tone 18	Tone 02
Tone 11	intermittent	720		0,7 s on / 0,3 s off	Industrial alarm Germany	119	Tone 02	Tone 29
Tone 12	intermittent	2400		0,5 s on / 0,5 s off		127	Tone 03	Tone 01
Tone 13	intermittent	2850		0,5 s on / 0,5 s off x 3 dann 1,5 s off	ISO 8201 high tone, US Temporal	120	Tone 03	Tone 17
Tone 14	alternating	440 - 554		0,4 s (440Hz) / 0,1 s (554Hz)	AFNOR France, NFS 32-001	116	Tone 16	Tone 01
Tone 15	alternating	554 - 440		1 Hz	Swedish Alarm	116	Tone 01	Tone 16
Tone 16	alternating	800 - 1000		2 Hz		120	Tone 02	Tone 09
Tone 17	alternating	2400 - 2900		2 Hz		125	Tone 03	Tone 01
Tone 18	alternating	1000 - 2000		1 Hz	Singapore	126	Tone 02	Tone 03
Tone 19	sweeping	500 - 1500		10 Hz		121	Tone 02	Tone 01
Tone 20	sweeping	150 - 1000		rising 10 s, 40 s on, falling 10 s	Industrial alarm Germany	116	Tone 01	Tone 29
Tone 21	continuous	400		simulated Horn		112	Tone 16	Tone 02
Tone 22	sweeping	500 - 1200		rising in 3,75 s/ 0,25 s off	Australian evacuation AS 2220	120	Tone 02	Tone 09
Tone 23	sweeping	500 - 1200		rising in 3,5 s/ 0,5 s off	Netherlands NEN 2575:2000	121	Tone 02	Tone 09
Tone 24	sweeping	500 - 1200		0,5 s on/0,5 s off x 3 / 1,5 s off	Australian evacuation AS1670	120	Tone 02	Tone 09
Tone 25	abfallend	1200 - 500		1 Hz	German evacuation DIN 33404-3	122	Tone 02	Tone 32
Tone 26	sweeping	500 - 1200		0,3 Hz		122	Tone 01	Tone 32
Tone 27	sweeping	1400 - 1600		rising in 1 s/falling in 0,5 s	NFC 48-265	124	Tone 02	Tone 09
Tone 28	sweeping	2400 - 2900		1 Hz		123	Tone 17	Tone 03
Tone 29	bell					122	Tone 16	Tone 02
Tone 30	slow rise	500 - 2400		siren rising 3 s, then continuous 2400 Hz		126	Tone 16	Tone 01
Tone 31	slow rise	300 - 1200		siren rising 3 s, then continuous 1200 Hz		113	Tone 16	Tone 01
Tone 32	chime	970 - 800		repeating ding-dong, 1 Hz		119	Tone 29	Tone 01

## ACL

## TONE TABLE

STAGE 1 S1	Tone type	Frequency Hz	Pictogram	Repeat rate	Specific application	max dB	STAGE 2 S2	STAGE 3 S3
Tone 33	continuous	340				112	Tone 16	Tone 03
Tone 34	continuous	500				112	Tone 16	Tone 03
Tone 35	continuous	825				119	Tone 16	Tone 03
Tone 36	continuous	1500				120	Tone 18	Tone 02
Tone 37	continuous	2850				116	Tone 21	Tone 01
Tone 38	intermittent	660		0,5 s on / 0,5 s off	Swedish Alarm	117	Tone 02	Tone 32
Tone 39	intermittent	680		0,875 s on / 0,675 s off		117	Tone 03	Tone 32
Tone 40	intermittent	950		1 s on / 1 s off		120	Tone 02	Tone 32
Tone 41	intermittent	1000		1 s on / 1 s off	PFEER general alarm	120	Tone 16	Tone 03
Tone 42	intermittent	800		4 ms on / 4 ms off		116	Tone 58	Tone 03
Tone 43	intermittent	825		0,5 s on / 0,5 s off		121	Tone 16	Tone 03
Tone 44	intermittent	825		2,5 s on, 2,5 s off x 7, then 7 s pulse	IMO SOLAS III/50+SOLAS III/6,4	120	Tone 17	Tone 02
Tone 45	alternating	440 - 554		1 Hz		115	Tone 16	Tone 01
Tone 46	alternating	825 - 1075		1 Hz		121	Tone 48	Tone 02
Tone 47	alternating	825 - 1025		2 Hz		121	Tone 48	Tone 03
Tone 48	alternating	2500 - 3100		0,5 Hz		121	Tone 60	Tone 03
Tone 49	alternating	2400 - 2850		2 Hz		124	Tone 12	Tone 03
Tone 50	alternating	500 - 900		2 Hz		118	Tone 41	Tone 02
Tone 51	alternating	1200 - 1400		25 Hz		122	Tone 41	Tone 02
Tone 52	sweeping	300 - 1200		1 Hz		121	Tone 03	Tone 32
Tone 53	sweeping	500 - 1000		0,15 Hz		120	Tone 41	Tone 02
Tone 54	sweeping	500 - 1200		3 Hz		121	Tone 41	Tone 02
Tone 55	sweeping	700 - 1500		0,3 Hz		122	Tone 16	Tone 02
Tone 56	sweeping	800 - 1000		7 Hz		119	Tone 16	Tone 02
Tone 57	sweeping	800 - 1000		50 Hz		90	Tone 16	Tone 02
Tone 58	sweeping	2400 - 2900		7 Hz		123	Tone 17	Tone 03
Tone 59	sweeping	2400 - 2900		50 Hz		90	Tone 17	Tone 03
Tone 60	sweeping	2400 - 2900		3 Hz		125	Tone 17	Tone 03
Tone 61	slow rise	0 - 800		siren rising 3 s, then continuous 800 Hz		118	Tone 16	Tone 01
Tone 62	chime	554 - 440		repeating ding-dong, 1 Hz		116	Tone 29	Tone 01
Tone 63	chime	554 - 440		single ding-dong		116	Tone 29	Tone 01

