

ADX Indicador multitono con Indicador luminoso

- sirena multitono cuadrada de 228 mm con indicador luminoso LED de luz fija o intermitente integrado
- tipo de luz controlable de forma externa
- para aplicaciones industriales y generales
- material estabilizado contra UV
- 63 tipos de tono seleccionables, 3 tipos de tono controlables de forma externa
- presión acústica máx. 127 dB (A)
- grado de protección alto IP65 y resistencia a los golpes IK09
- montaje opcional con escuadra metálica

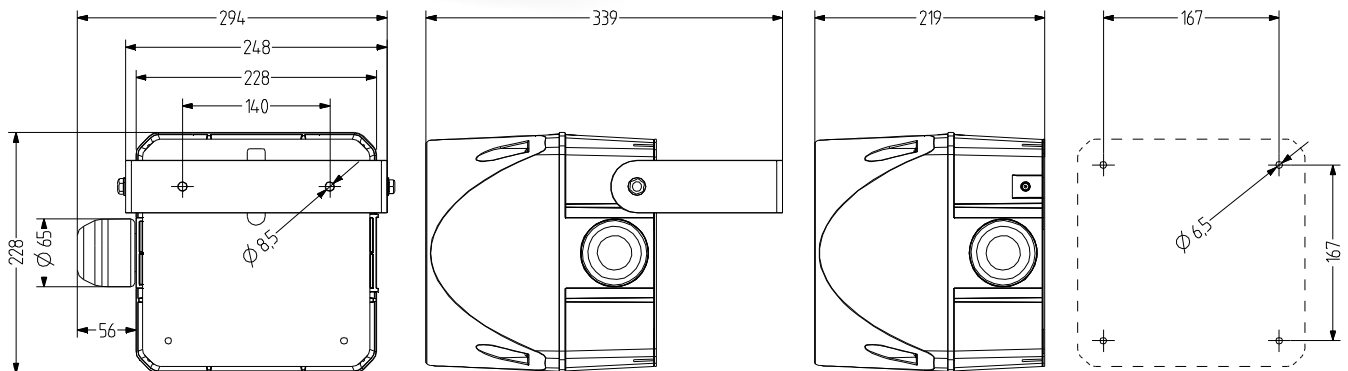

DATOS TÉCNICOS

Carcasa	228 mm [cuadrado], Policarbonato rojo
Calota	Policarbonato, interior acanalado naranja, rojo, claro, azul, verde o amarillo
Tipo de montaje	Cualquiera, Apertura de salida de sonido hacia abajo u horizontal
Técnica de conexión	Terminal de rosca-enchufable bis 2,5 mm ²
Tipo de luz	Luz fija o Indicador luz intermitente
Intensidad luminosa	3 Cd
Frecuencia de destello/ parpadeo	1 Hz
Tipo de tono	63 Tonos, 3 Tonos controlables de forma externa, diversos (véase la tabla de tonos)

Volumen	127 dB
Frecuencia de tono	150-3.100 Hz
Período de funcionamiento	100 %
Vida útil	Elementos de iluminación: 100.000 h
Temperatura de funcionamiento	-30 °C / +60 °C
Grado de protección	IP65
Resistencia a impactos	IK09
Peso	3,58 kg

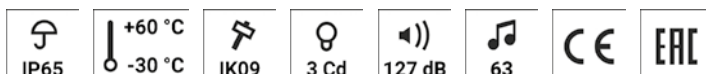

ADX

DATOS DEL PEDIDO

Color de la calota	Tensión nominal	Rango de voltaje (V)	Corriente nominal (A)	Número de artículo
naranja	24 V CA/CC	+/- 10 %	2,560	875 461 405
	110-120 V CA	+/- 10 %	0,830	875 461 310
	230-240 V CA	+/- 10 %	0,480	875 461 313
rojo	24 V CA/CC	+/- 10 %	2,560	875 462 405
	110-120 V CA	+/- 10 %	0,830	875 462 310
	230-240 V CA	+/- 10 %	0,480	875 462 313
claro	24 V CA/CC	+/- 10 %	2,560	875 464 405
	110-120 V CA	+/- 10 %	0,830	875 464 310
	230-240 V CA	+/- 10 %	0,480	875 464 313
azul	24 V CA/CC	+/- 10 %	2,560	875 465 405
	110-120 V CA	+/- 10 %	0,830	875 465 310
	230-240 V CA	+/- 10 %	0,480	875 465 313
verde	24 V CA/CC	+/- 10 %	2,560	875 466 405
	110-120 V CA	+/- 10 %	0,830	875 466 310
	230-240 V CA	+/- 10 %	0,480	875 466 313
amarillo	24 V CA/CC	+/- 10 %	2,560	875 467 405
	110-120 V CA	+/- 10 %	0,830	875 467 310
	230-240 V CA	+/- 10 %	0,480	875 467 313



AMK



AB4



AG4



AKV













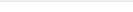

















ACCESORIOS

Type	Tipo de accesorios	Peso	Número de artículo
AMK	Set de montaje para la combinación de varios equipos de señalización del mismo tamaño	10 g	874 010 900
AB4	Kit de montaje para escuadra metálica para el montaje en cualquier dirección (p. ej. en plataformas de montaje)		874 034 900
AG4	Junta plana para la instalación en superficies lisas		874 024 900
AKV	Prensaestopa M20x1,5		698 800 026



ADX

TABLA DE TONOS

PASO 1 S1	Tipo de tono	Frecuencia Hz	Pictograma	Velocidad de repetición	Aplicación específica	max dB	PASO 2 S2	PASO 3 S3
Tono 01	continuo	660			Alarma Sueca	114	Tono 16	Tono 12
Tono 02	continuo	1000			PFEER gas tóxico	113	Tono 16	Tono 25
Tono 03	continuo	2400				120	Tono 21	Tono 17
Tono 04	intermitente	420		0,625 s on / 0,625 s off	Alarma Australiana AS1670	109	Tono 21	Tono 01
Tono 05	intermitente	660		1,8 s on / 1,8 s off	Alarma Sueca	114	Tono 21	Tono 01
Tono 06	intermitente	660		0,15 s on / 0,15 s off	Alarma Sueca	114	Tono 16	Tono 01
Tono 07	intermitente	970		1 s on, 1 s off	PFEER Alarma, BS5839-1:2002	113	Tono 18	Tono 01
Tono 08	intermitente	970 (950)		0,5 s on/0,5 s off x 3 dann 1,5 s off	ISO 8201 Tono bajo, US Temporal	113	Tono 16	Tono 03
Tono 09	intermitente	800		0,25 s on / 1 s off		112	Tono 27	Tono 03
Tono 10	intermitente	700		0,15 s on / 0,15 s off, total 1 min.	Alarma Sueca SS 031711	112	Tono 18	Tono 02
Tono 11	intermitente	720		0,7 s on / 0,3 s off	Alarma industrial Alemana	111	Tono 02	Tono 29
Tono 12	intermitente	2400		0,5 s on / 0,5 s off		120	Tono 03	Tono 01
Tono 13	intermitente	2850		0,5 s on / 0,5 s off x 3 dann 1,5 s off	ISO 8201 Tono alto, US Temporal	111	Tono 03	Tono 17
Tono 14	alterno	440 - 554		0,4 s (440Hz) / 0,1 s (554Hz)	AFNOR Francia, NFS 32-001	109	Tono 16	Tono 01
Tono 15	alterno	554 - 440		1 Hz	Alarma Sueca	109	Tono 01	Tono 16
Tono 16	alterno	800 - 1000		2 Hz		113	Tono 02	Tono 09
Tono 17	alterno	2400 - 2900		2 Hz		120	Tono 03	Tono 01
Tono 18	alterno	1000 - 2000		1 Hz	Singapur	120	Tono 02	Tono 03
Tono 19	barrido	500 - 1500		10 Hz		119	Tono 02	Tono 01
Tono 20	barrido	150 - 1000		ascenso 10 s, 40 s on, descenso 10 s	Alarma industrial Alemana	114	Tono 01	Tono 29
Tono 21	continuo	400		bocina simulada		109	Tono 16	Tono 02
Tono 22	barrido	500 - 1200		ascenso en 3,75 s / 0,25 s off	Evacuación Australiana AS 2220	117	Tono 02	Tono 09
Tono 23	barrido	500 - 1200		ascenso en 3,5 s / 0,5 s off	Holanda NEN 2575:2000	117	Tono 02	Tono 09
Tono 24	barrido	500 - 1200		0,5 s on/0,5 s off x 3 / 1,5 s off	Evacuación Australiana AS1670	117	Tono 02	Tono 09
Tono 25	descenso	1200 - 500		1 Hz	Evacuación Alemana DIN 33404-3	117	Tono 02	Tono 32
Tono 26	barrido	500 - 1200		0,3 Hz		117	Tono 01	Tono 32
Tono 27	barrido	1400 - 1600		ascenso en 1 s / descenso en 0,5 s	NFC 48-265	119	Tono 02	Tono 09
Tono 28	barrido	2400 - 2900		1 Hz		120	Tono 17	Tono 03
Tono 29	campana					120	Tono 16	Tono 02
Tono 30	ascenso lento	500 - 2400		Sirena en ascenso 3 s, después cont 2400 Hz		120	Tono 16	Tono 01
Tono 31	ascenso lento	300 - 1200		Sirena en ascenso 3 s, después cont 1200 Hz		117	Tono 16	Tono 01
Tono 32	timbre	970 - 800		ding-dong repetido, 1 Hz		113	Tono 29	Tono 01

ADX

TABLA DE TONOS

PASO 1 S1	Tipo de tono	Frecuencia Hz	Píctograma	Velocidad de repetición	Aplicación específica	max dB	PASO 2 S2	PASO 3 S3
Tono 33	continuo	340				109	Tono 16	Tono 03
Tono 34	continuo	500				109	Tono 16	Tono 03
Tono 35	continuo	825				113	Tono 16	Tono 03
Tono 36	continuo	1500				118	Tono 18	Tono 02
Tono 37	continuo	2850				111	Tono 21	Tono 01
Tono 38	intermitente	660		0,5 s on / 0,5 s off	Alarma Sueca	114	Tono 02	Tono 32
Tono 39	intermitente	680		0,875 s on / 0,675 s off		114	Tono 03	Tono 32
Tono 40	intermitente	950		1 s on / 1 s off		114	Tono 02	Tono 32
Tono 41	intermitente	1000		1 s on / 1 s off	PFEER Alarma general	113	Tono 16	Tono 03
Tono 42	intermitente	800		4 ms on / 4 ms off		112	Tono 58	Tono 03
Tono 43	intermitente	825		0,5 s on / 0,5 s off		113	Tono 16	Tono 03
Tono 44	intermitente	825		2,5 s on, 2,5 s off x 7, después 7 s intermitente	IMO SOLAS III/50+SOLAS III/6,4	113	Tono 17	Tono 02
Tono 45	alterno	440 - 554		1 Hz		109	Tono 16	Tono 01
Tono 46	alterno	825 - 1075		1 Hz		114	Tono 48	Tono 02
Tono 47	alterno	825 - 1025		2 Hz		114	Tono 48	Tono 03
Tono 48	alterno	2500 - 3100		0,5 Hz		117	Tono 60	Tono 03
Tono 49	alterno	2400 - 2850		2 Hz		120	Tono 12	Tono 03
Tono 50	alterno	500 - 900		2 Hz		114	Tono 41	Tono 02
Tono 51	alterno	1200 - 1400		25 Hz		119	Tono 41	Tono 02
Tono 52	barrido	300 - 1200		1 Hz		117	Tono 03	Tono 32
Tono 53	barrido	500 - 1000		0,15 Hz		114	Tono 41	Tono 02
Tono 54	barrido	500 - 1200		3 Hz		117	Tono 41	Tono 02
Tono 55	barrido	700 - 1500		0,3 Hz		119	Tono 16	Tono 02
Tono 56	barrido	800 - 1000		7 Hz		114	Tono 16	Tono 02
Tono 57	barrido	800 - 1000		50 Hz		114	Tono 16	Tono 02
Tono 58	barrido	2400 - 2900		7 Hz		120	Tono 17	Tono 03
Tono 59	barrido	2400 - 2900		50 Hz		120	Tono 17	Tono 03
Tono 60	barrido	2400 - 2900		3 Hz		120	Tono 17	Tono 03
Tono 61	ascenso lento	0 - 800		Sirena en ascenso 3 s, después cont 800 Hz		114	Tono 16	Tono 01
Tono 62	timbre	554 - 440		ding-dong repetido, 1 Hz		109	Tono 29	Tono 01
Tono 63	timbre	554 - 440		un solo ding-dong		109	Tono 29	Tono 01

