

# HPT Signal horn

- Well-designed electromechanical signal horn
- For industrial and general applications
- Degree of protection IP 55
- Fully developed and proven technology – typical horn tone
- Comprehensive range of AC and DC nominal voltages
- Mounting holes with steel inserts



## TECHNICAL DATA

Housing	ABS grey (RAL 7035)
Type of mounting	any, Sound outlet opening at bottom
Cable entry	7-10 mm
Connection technology	Terminal up to 2,5 mm <sup>2</sup>
Tone	Steady tone
Volume	108 dB
Duty cycle	100 %
Operating temperature	-20 °C / +50 °C
Degree of protection	IP55
Weight	800 g

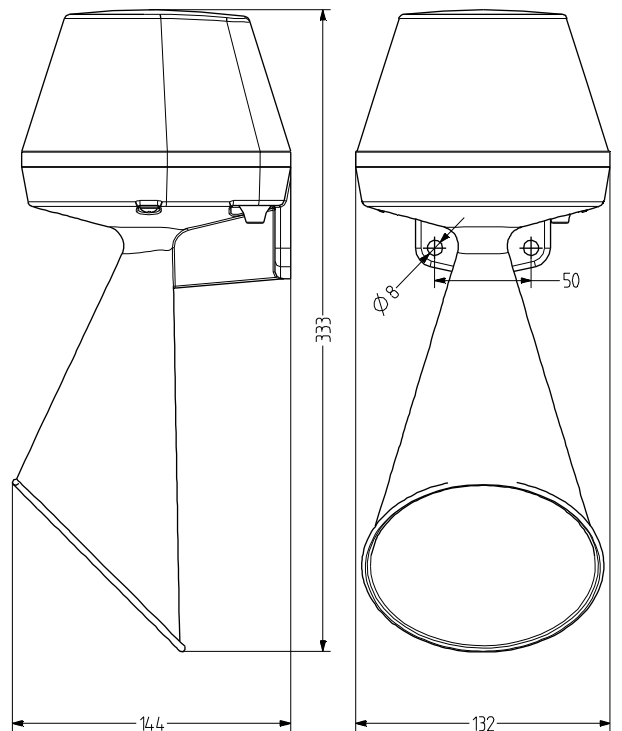

# HPT

## ORDER DATA

Nominal voltage	Voltage range (V)	Nominal current (A)	Mains frequency	Order number
24 V AC	+/- 10 %	1,200	50 Hz	712 100 105
24 V DC	+/- 10 %	0,600		712 100 005
48 V AC	+/- 10 %	0,500	50 Hz	712 100 108
110 V AC	+/- 10 %	0,240	50 Hz	712 100 110
120 V AC	+/- 10 %	0,200	60 Hz	712 100 211
230 V AC	+/- 10 %	0,140	50 Hz	712 100 113
240 V AC	+/- 10 %	0,120	60 Hz	712 100 213

