

## ADM Emittitori sonori d'allarme multitono con Indicatore di Faro a LED

- Sirena con diversi suoni quadrata di 132 mm con indicatore di illuminazione LED continua/ lampeggiante di grandi dimensioni
- Tipi di Faro impostabili dall'esterno
- per gli utilizzi industriali e generali
- Materiale resistente ai raggi ultravioletti
- possibilità di scegliere fra 32 tipi di suono, 3 tipi di suono controllabili dall'esterno
- max 113 dB (A) pressione del suono a regolazione continua
- tipo di montaggio opzionale con angolo in metallo

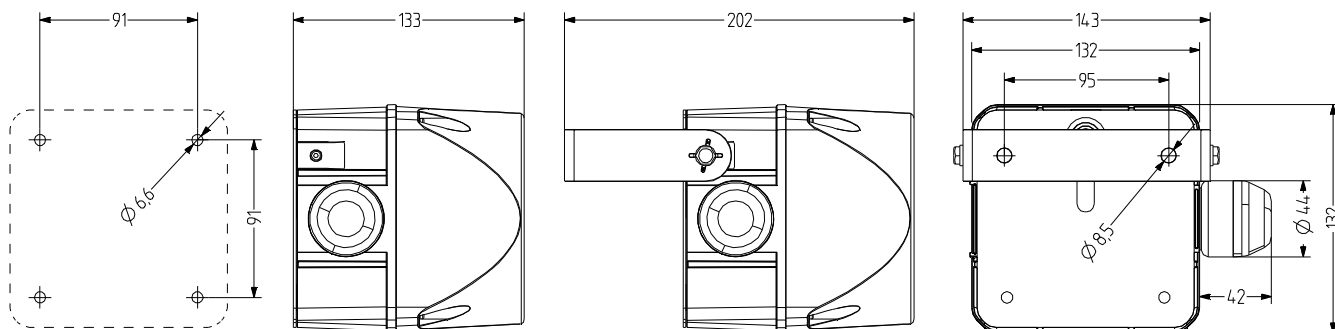

### DATI TECNICI

Involucro	132 mm (quadrato), policarbonato rosso
Calotta	policarbonato, rigato all'interno arancione, rosso, chiaro, blu, verde oppure giallo
Tipo di montaggio	a discrezione, Apertura di emissione del suono verso il basso o in orizzontale
Tecnica di collegamento	Morsetto a vite e ad inserimento bis 2,5 mm <sup>2</sup>
Tipo di Faro	Faro Statico oppure Faro lampeggiante
Isointensità	2 Cd
Frequenza di intermittenza/lampeggio	1 Hz

Tipo di suono	32 suoni, 3 suoni regolabili dall'esterno diversi (vedere tabella dei suoni)
Volume	113 dB (regolabile tramite potenziometro)
Frequenza del suono	150-2.900 Hz
Durata di accensione	100 %
Durata di vita	Mezzo di illuminazione 100.000 h
Temperatura durante il funzionamento	-30 °C / +60 °C
Tipo di protezione	IP65
Resistenza agli urti	IK07
Peso	660 g

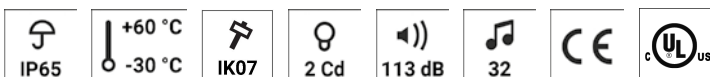

# ADM

## DATI RELATIVI ALL'ORDINAZIONE

Colore della calotta	Tensione nominale	Campo di tensione (V)	Corrente nominale (A)	Numero articolo
arancione	24 V AC/DC	+/- 10 %	0,267	875 271 405
	110-120 V AC	+/- 10 %	0,100	875 271 310
	230-240 V AC	+/- 10 %	0,100	875 271 313
rosso	24 V AC/DC	+/- 10 %	0,267	875 272 405
	110-120 V AC	+/- 10 %	0,100	875 272 310
	230-240 V AC	+/- 10 %	0,100	875 272 313
giallo	24 V AC/DC	+/- 10 %	0,267	875 277 405
	110-120 V AC	+/- 10 %	0,100	875 277 310
	230-240 V AC	+/- 10 %	0,100	875 277 313



AMK



AB2



AG2



AKV













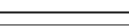



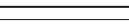



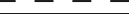



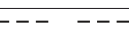



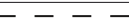

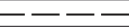

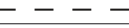

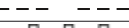















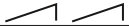

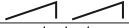

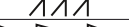









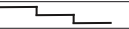

## ACCESSORI

Type	Tipo di accessorio	Peso	Numero articolo
AMK	Set da montaggio per la combinazione di diverse apparecchiature di segnalazione della stessa dimensione	10 g	874 010 900
AB2	Assortimento di montaggio per angolo in metallo per il montaggio nella direzione preferita (ad es. su piattaforme di montaggio)		874 032 900
AG2	Guarnizione piana per la installazione su super ici lisce		874 022 900
AKV	Pressacavo M20x1,5		698 800 026



## ADM

## TABELLA DEI SUONI

STAGE 1 S1	Tone type	Frequency Hz	Pictogram	Repeat rate	Specific application	ASS-T/ADS-T	ASM	ASL	ASX	STAGE 2 S2	STAGE 3 S3		
						max dB	 ADS-T	max dB	max dB			max dB	
	Tone 01	continuous	660 Hz		Swedish alarm	103	—	107	116	tone 16	tone 12		
	Tone 02	continuous	1000 Hz		PFEER toxic gas	97	—	110	121	tone 16	tone 25		
	Tone 03	continuous	2400 Hz			106	—	111	120	tone 21	tone 17		
	Tone 04	intermittent	420 Hz		0,625 s on / 0,625 s off	Australian alert AS1670	98	----	106	109	117	tone 21	tone 01
	Tone 05	intermittent	660 Hz		1,8 s on - 1,8 s off	Swedish alarm	103	----	107	114	117	tone 21	tone 01
	Tone 06	intermittent	660 Hz		0,15 s on / 0,15 s off	Swedish alarm	103	----	107	114	117	tone 16	tone 01
	Tone 07	intermittent	970 Hz		1 s on, 1 sec off	PFEER Alarm, BS5839-1:2002	99	----	111	113	122	tone 18	tone 01
	Tone 08	intermittent	970 Hz (950)		0,5 s on/0,5 s off x 3 then 1 s off	ISO 8201 low tone, US Temporal	101	----	111	113	122	tone 16	tone 03
	Tone 09	intermittent	800 Hz		0,25 s on / 1 s off		108	----	112	112	124	tone 27	tone 03
	Tone 10	intermittent	700 Hz		0,15 s on / 0,15 s off, total 1 min.	Swedish alarm SS 031711	102	----	107	112	119	tone 18	tone 02
	Tone 11	intermittent	720 Hz		0,7 s on / 0,3 s off	Industrial Alarm Germany	102	----	110	111	123	tone 02	tone 29
	Tone 12	intermittent	2400 Hz		0,5 s on / 0,5 s off		106	----	111	120	126	tone 03	tone 01
	Tone 13	intermittent	2850 Hz		0,5 s on/0,5 s off x 3 then 1 s off	ISO 8201 high tone, US Temporal	97	----	108	111	120	tone 03	tone 17
	Tone 14	alternating	440 - 554 Hz		0,4 s (440Hz) / 0,1 s (554Hz)	AFNOR France, NFS 32-001	103	—	109	109	118	tone 16	tone 01
	Tone 15	alternating	554 - 440 Hz		1 Hz	Swedish alarm	103	—	109	109	118	tone 01	tone 16
	Tone 16	alternating	800 - 1000 Hz		2 Hz		108	—	113	113	121	tone 02	tone 09
	Tone 17	alternating	2400 - 2900 Hz		2 Hz		106	—	111	120	126	tone 03	tone 01
	Tone 18	alternating	1000 - 2000 Hz		1 Hz	Singapore	107	—	110	120	127	tone 02	tone 03
	Tone 19	sweeping	500 - 1500 Hz		10 Hz		108	—	113	119	124	tone 02	tone 01
	Tone 20	sweeping	150 - 1000 Hz		rising 10 s, 40 s on, falling 10 s	Industrial Alarm Germany	108	—	113	114	123	tone 25	tone 29
	Tone 21	continuous	400 Hz		simulated horn		101	—	106	109	115	tone 16	tone 02
	Tone 22	sweeping	500 - 1200 Hz		rising in 3,75 s / 0,25 s off	Australian evacuation AS 2220	108	—	113	117	124	tone 02	tone 09
	Tone 23	sweeping	500 - 1200 Hz		rising in 3,5 s / 0,5 s off	Netherlands NEN 2575:2000	108	—	113	117	124	tone 02	tone 09
	Tone 24	sweeping	500 - 1200 Hz		0,5 s on/0,5 s off x 3 / 1,5 s off	Australia AS1670 evacuation	108	—	113	117	124	tone 02	tone 09
	Tone 25	sweeping	1200 - 500 Hz		1 Hz	evacuation Germany, DIN 33404-3	108	—	113	117	124	tone 02	tone 32
	Tone 26	sweeping	500 - 1200 Hz		0,3 Hz		108	—	113	117	124	tone 01	tone 32
	Tone 27	sweeping	1400 - 1600 Hz		rising in 1 s/falling in 0,5 s	NFC 48-265	102	—	110	119	124	tone 02	tone 09
	Tone 28	sweeping	2400 - 2900 Hz		1 Hz		106	—	111	120	126	tone 17	tone 03
	Tone 29	bell					102	—	108	120	122	tone 16	tone 02
	Tone 30	slow rise	500 - 2400 Hz		siren rising in 3 s, then cont. 2400 Hz		108	—	113	120	127	tone 16	tone 01
	Tone 31	slow rise	300 - 1200 Hz		siren rising in 3 s, then cont. 1200 Hz		108	—	113	117	124	tone 16	tone 01
	Tone 32	3-tone gong	660-550-440 Hz		repeating 3-tone gong, 7s		90	—	93	X	X	tone 29	tone 01
		chime	970 - 800 Hz		repeating ding-dong, 1 Hz		X	X	113	123		tone 29	tone 01